

RoHS
COMPLIANT

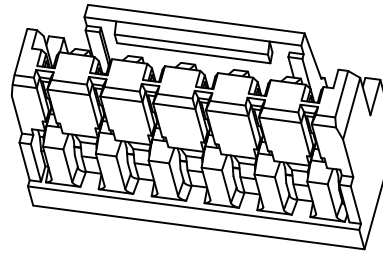
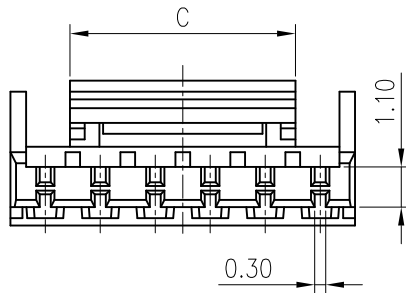

SPECIFICATIONS

Current rating: 1A AC, DC
Voltage rating: 50V AC, DC
Temperature range: -40°C ~ +105°C
Insulation resistance: 100MΩ/ min.
Withstanding voltage: 500V AC/ minute.
Contact resistance: 30mΩ/ max.

Material: Nylon66 UL94 V-0
Suitable KR1259 Series Terminal
Mates With KR1506 Series Wafer

Ordering code:
H15060 *** 0101A
102=02P
103=03P
.....

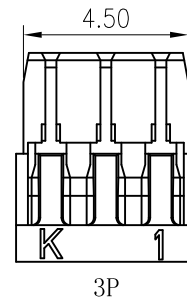
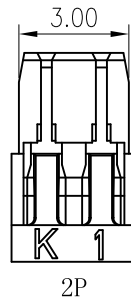
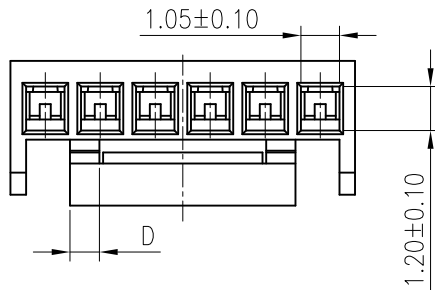
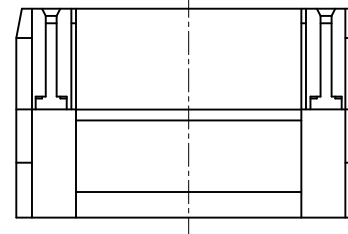
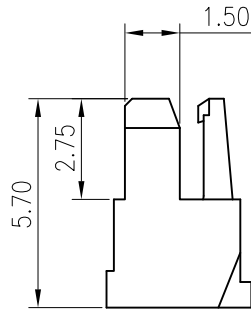
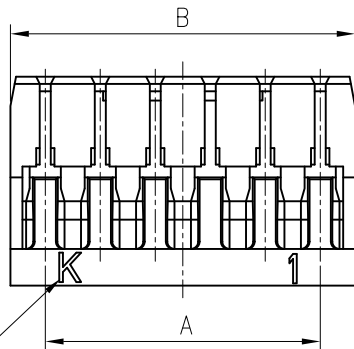

PIN	Dimensions			
	A	B	C	D
2P	1.50	3.00	1.90	0.50
3P	3.00	4.50	2.90	0.80
4P	4.50	6.40	4.15	
5P	6.00	7.90	4.15	
6P	7.50	9.40	6.15	

F		Uniformly arrange the drawings	Shen	2021.09.28	TOLERANCE X.X ±0.25 X.XX ±0.15 X.XXX ±0.08 Angle ±2°	TITLE: GH1.5 Housing	DRAWN: Shen 2021.09.28		KONNRA 东莞市康瑞电子有限公司 DongGuan Konnra Electronics Co.,Ltd.		
		Change the part number and frame format	TLX	2020.04.08			CHECKED:				
	MARK		REVISION DESCRIPTION	SIGNATURE			DATE	APPROVED:			
	1	2	3	4	UNIT:mm	SCALE: 1/1	SHEET: 1/1	PROJECTION	REV.: A3	DRAWING NO.: 1506H01-A-S	